



Package Style: SOT89



Features

- 200MHz to 2200MHz
- +41dBm Output IP3
- 18dB Gain at 900MHz
- +25dBm P1dB
- 2.5dB Typical Noise Figure at 900MHz
- Single 5V Power Supply
- Class 1A ESD Rating (All Pins)

Applications

- Broadband MoCA PA
- Linear Driver with Low NF
- High Linearity IF Amplifier

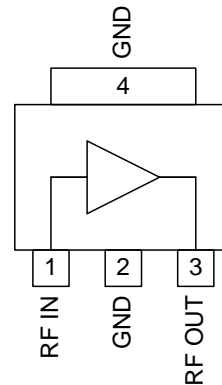

Functional Block Diagram

Product Description

The RF3315 is a high-efficiency GaAs Heterojunction Bipolar Transistor (HBT) amplifier packaged in a low-cost surface-mount package. This amplifier is ideal for use in applications requiring high-linearity and low noise figure over the 200MHz to 2200MHz frequency range. This part offers exceptional broadband performance for MoCA applications in the 400MHz to 700MHz and 800MHz to 1500MHz bands. The RF3315 operates from a single 5V power supply.

Ordering Information

RF3315SQ	Sample bag with 25 pieces
RF3315SR	7" Sample reel with 100 pieces
RF3315TR13	13" Reel with 2500 pieces
RF3315PCK-413	900MHz PCBA with 5-piece sample bag

Optimum Technology Matching® Applied

- | | | | |
|--|--------------------------------------|-------------------------------------|------------------------------------|
| <input checked="" type="checkbox"/> GaAs HBT | <input type="checkbox"/> SiGe BiCMOS | <input type="checkbox"/> GaAs pHEMT | <input type="checkbox"/> GaN HEMT |
| <input type="checkbox"/> GaAs MESFET | <input type="checkbox"/> Si BiCMOS | <input type="checkbox"/> Si CMOS | <input type="checkbox"/> BiFET HBT |
| <input type="checkbox"/> InGaP HBT | <input type="checkbox"/> SiGe HBT | <input type="checkbox"/> Si BJT | |

RF MICRO DEVICES®, RFMD®, Optimum Technology Matching®, Enabling Wireless Connectivity™, PowerStar®, POLARIS™ TOTAL RADIO™ and UltimateBlue™ are trademarks of RFMD, LLC. BLUETOOTH is a trademark owned by Bluetooth SIG, Inc., U.S.A. and licensed for use by RFMD. All other trade names, trademarks and registered trademarks are the property of their respective owners. ©2012, RF Micro Devices, Inc.

Absolute Maximum Ratings

Parameter	Rating	Unit
RF Input Power	+20	dBm
Device Voltage	-0.5 to +6.0	V
Device Current	225	mA
Operating Temperature	-40 to +85	°C
Storage Temperature	-40 to +150	°C
Max. T _J (MTTF ≥100 years)	165	°C



Caution! ESD sensitive device.

Exceeding any one or a combination of the Absolute Maximum Rating conditions may cause permanent damage to the device. Extended application of Absolute Maximum Rating conditions to the device may reduce device reliability. Specified typical performance or functional operation of the device under Absolute Maximum Rating conditions is not implied.

The information in this publication is believed to be accurate and reliable. However, no responsibility is assumed by RF Micro Devices, Inc. ("RFMD") for its use, nor for any infringement of patents, or other rights of third parties, resulting from its use. No license is granted by implication or otherwise under any patent or patent rights of RFMD. RFMD reserves the right to change component circuitry, recommended application circuitry and specifications at any time without prior notice.



RFMD Green: RoHS compliant per EU Directive 2002/95/EC, halogen free per IEC 61249-2-21, < 1000ppm each of antimony trioxide in polymeric materials and red phosphorus as a flame retardant, and <2% antimony in solder.

Parameter	Specification			Unit	Condition
	Min.	Typ.	Max.		
Overall					
AC Specifications (2GHz)					V _{CC} = 5V, RF _{IN} = -10dBm, Freq = 2.0GHz, with 2GHz application schematic.
Frequency	200		2200	MHz	
Gain (Small Signal)		12.5		dB	F = 2GHz
Input Return Loss		15		dB	F = 2GHz
Output Return Loss		15		dB	F = 2GHz
Output IP3		+40.0		dBm	F ₁ = 1.99GHz, F ₂ = 2.00GHz, P _{IN} = -5dBm
Output P1dB		+23.0		dBm	
Noise Figure		3.0		dB	
AC Specifications (900MHz)					V _{CC} = 5V, RF _{IN} = -10dBm, Freq = 900MHz, with 900MHz application schematic.
Frequency				MHz	
Gain (Small Signal)	17	18		dB	
Input Return Loss		20		dB	
Output Return Loss		15		dB	
Output IP3	+38.5	+41		dBm	F ₁ = 900MHz, F ₂ = 901MHz, P _{IN} = -10dBm
Output P1dB	+23.5	+25.0		dBm	
Noise Figure		2.5		dB	
Thermal					I _{CC} = 150mA, P _{DISS} = 750mW. (See Note.)
Theta _{JC}		76		°C/W	
Maximum Measured Junction Temperature at DC Bias Conditions		142		°C	T _{CASE} = +85°C
Mean Time To Failure		>100		years	T _{CASE} = +85°C
DC Specifications					
Device Voltage		5.0		V	I _{CC} = 150mA
Operating Current Range	115	150	170	mA	V _{CC} = 5V

Note: The RF3315 must be operated at or below 170mA to ensure the highest possible reliability and electrical performance.

Pin Names and Descriptions

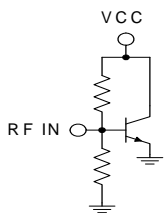
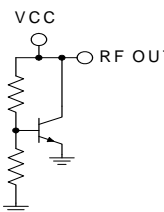
Pin	Name	Description	Interface Schematic
1	RF IN	RF input pin. This pin is <u>not</u> internally DC-blocked. A DC blocking capacitor, suitable for the frequency of operation, should be used.	
2	GND	Ground connection.	
3	RF OUT	RF output and bias pin. For biasing, an RF choke is needed. Because DC is present on this pin, a DC blocking capacitor, suitable for the frequency of operation, should be used. See application schematic for configuration and value.	
4	GND	Ground connection.	
Pkg Base	GND	Ground connection.	

Package Drawing

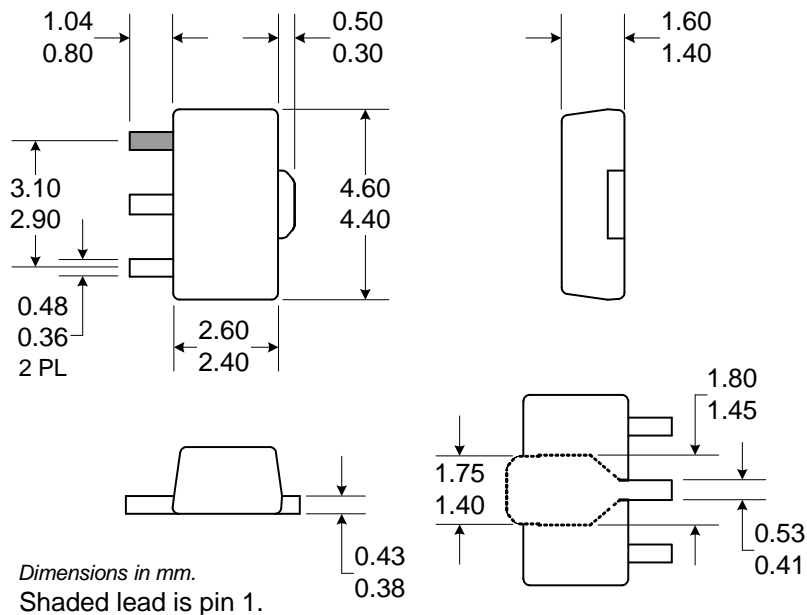

900MHz Data

Frequency (MHz)	V _{CC} (V)	I _{CC} (mA)	P _{IN} (dBm)	P _{OUT} (dBm)	Gain (dB)	OIP3 (dBm)	OP1dB (dBm)
900	5	149.49	-9.9	8	17.9	41.73	24.15

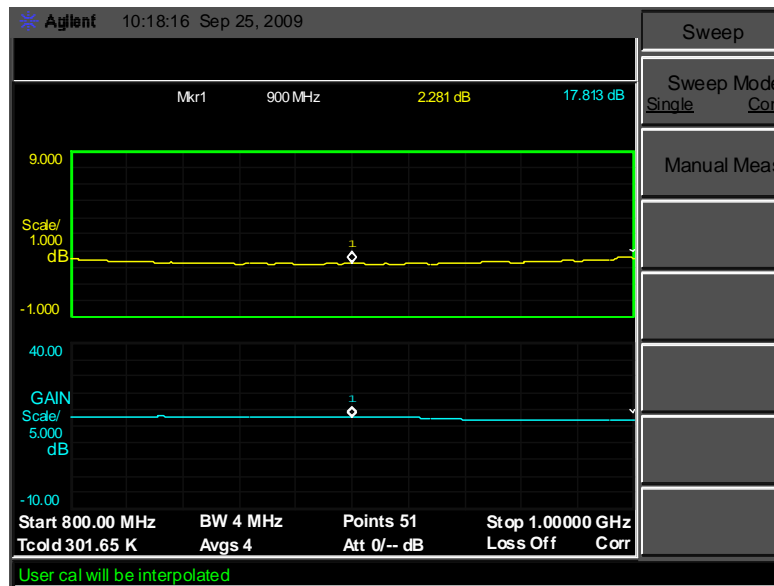
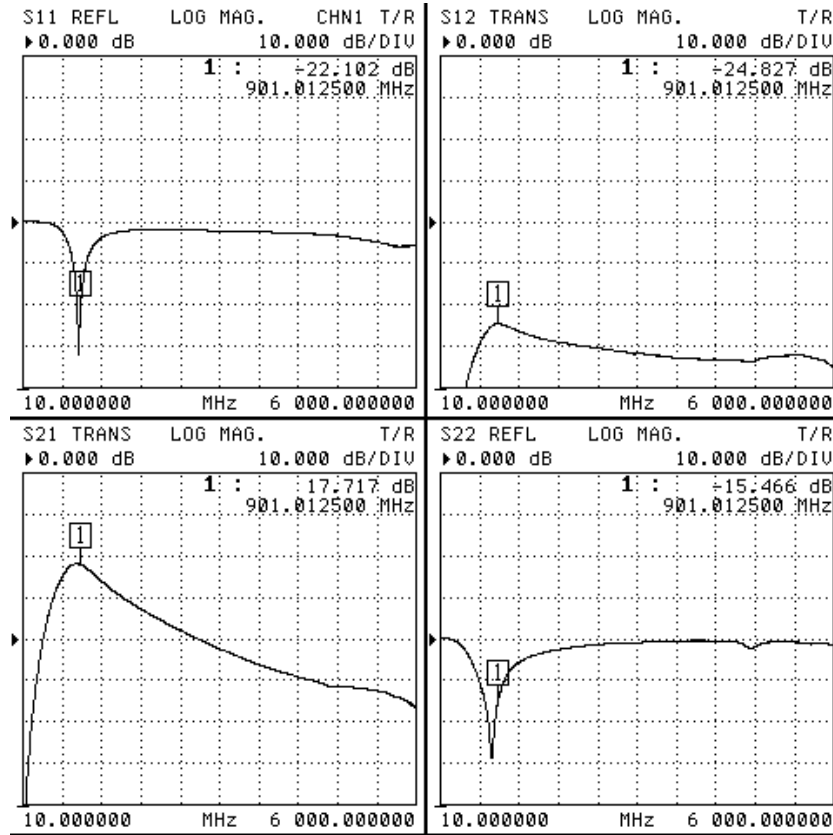

2GHz Data

Frequency (MHz)	V _{CC} (V)	I _{CC} (mA)	P _{IN} (dBm)	P _{OUT} (dBm)	Gain (dB)	OIP3 (dBm)	OP1dB (dBm)
2000	5	151.53	-4.88	8	12.89	41.4	24.76

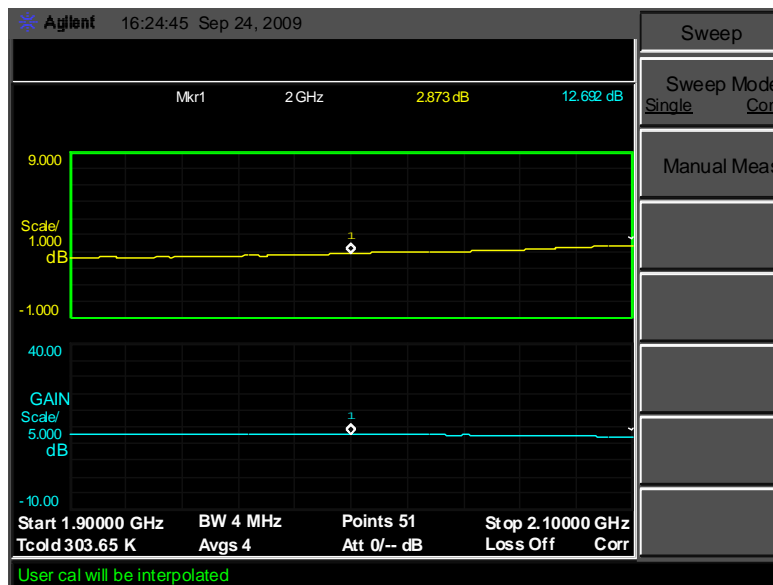
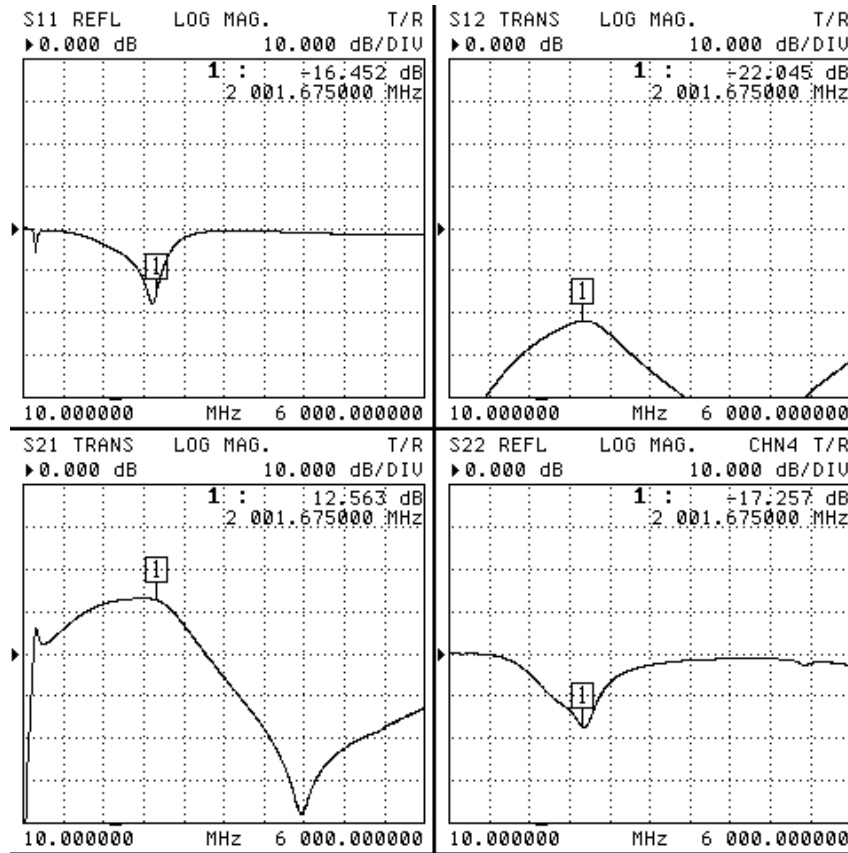

400MHz to 700MHz Data

Frequency (MHz)	V _{CC} (V)	I _{CC} (mA)	P _{IN} (dBm)	P _{OUT} (dBm)	Gain (dB)	OIP3 (dBm)	OP1dB (dBm)
400	5	147.12	-12.36	8	20.35	41.95	24.02
550	5	147.47	-11.64	8	19.62	40.54	24.22
700	5	147.62	-10.98	8	18.96	40.59	24.94

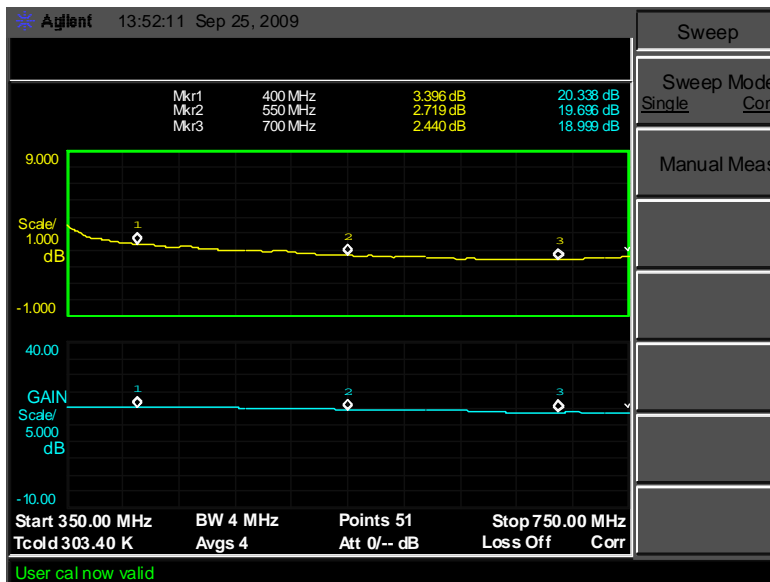
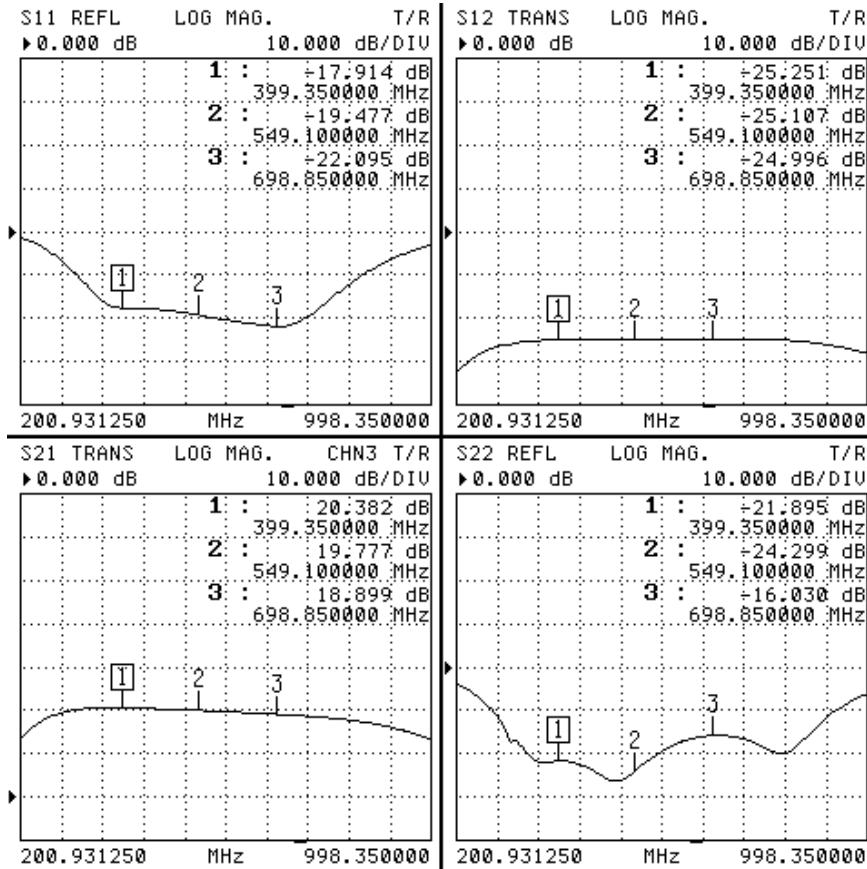

800MHz to 1500MHz Data

Frequency (MHz)	V _{CC} (V)	I _{CC} (mA)	P _{IN} (dBm)	P _{OUT} (dBm)	Gain (dB)	OIP3 (dBm)	OP1dB (dBm)
800	5	148.52	-10.72	8	18.72	41.35	24.7
960	5	148.87	-9.42	8	17.42	42.29	25
1150	5	149.12	-8.4	8	16.39	42.8	25.16
1500	5	149	-6.22	8	14.21	42.85	24.61

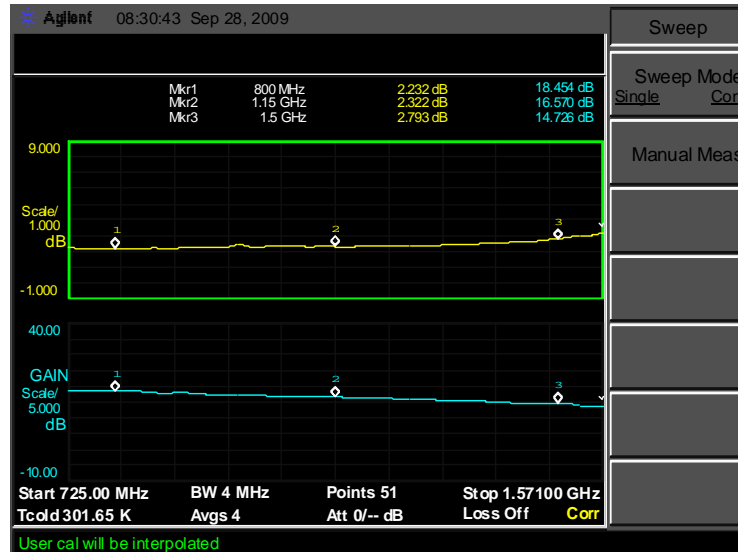
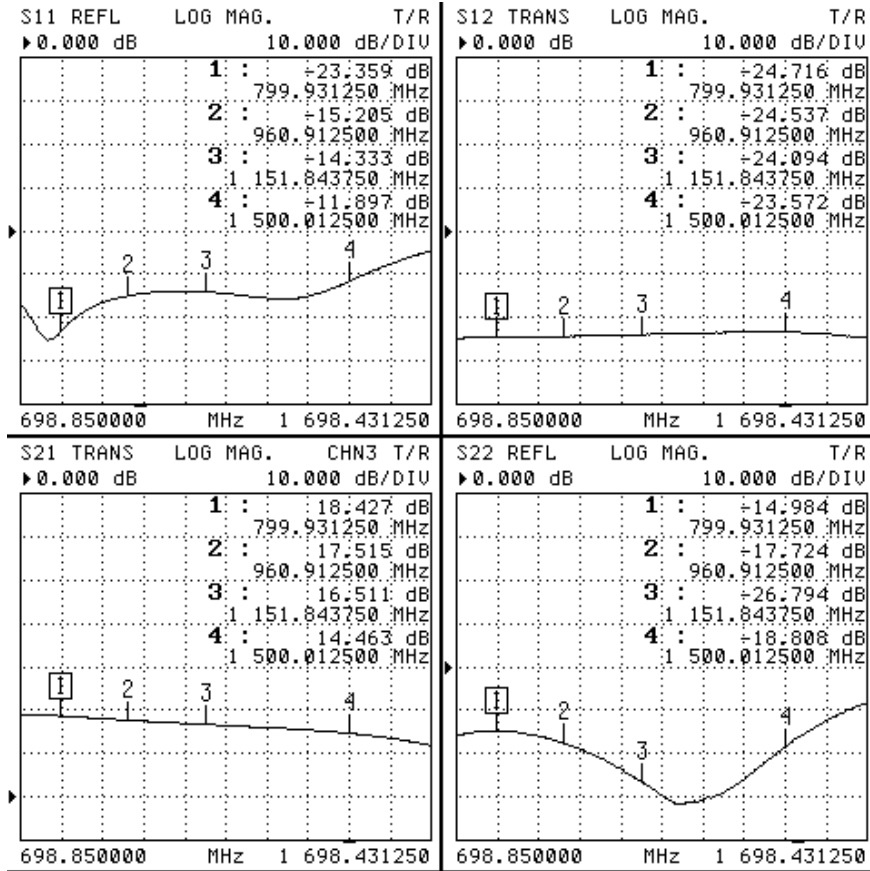

Typical Application Schematic for 2GHz

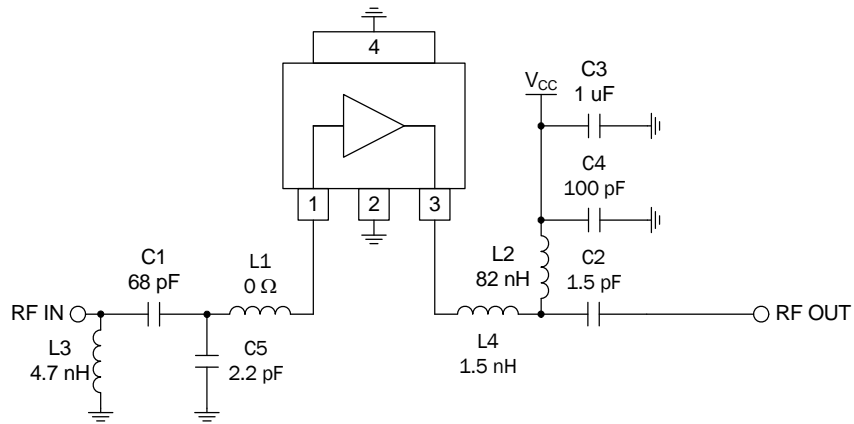

Typical Application Schematic for 400MHz to 700MHz Broadband Match

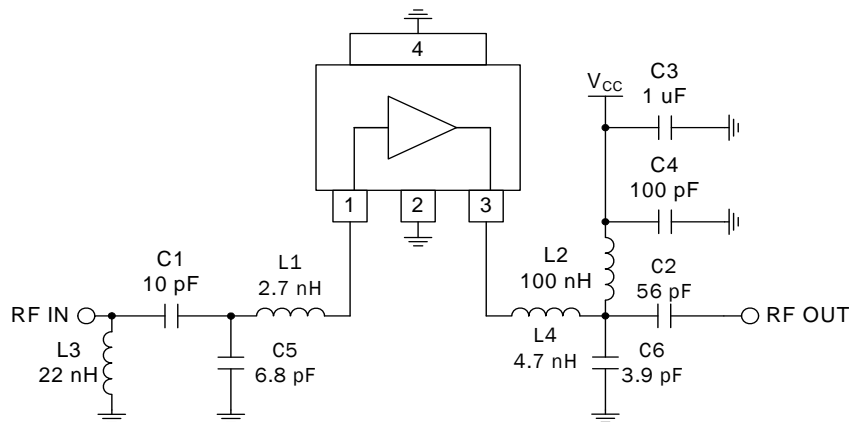

Typical Application Schematic for 800MHz to 1500MHz Broadband Match

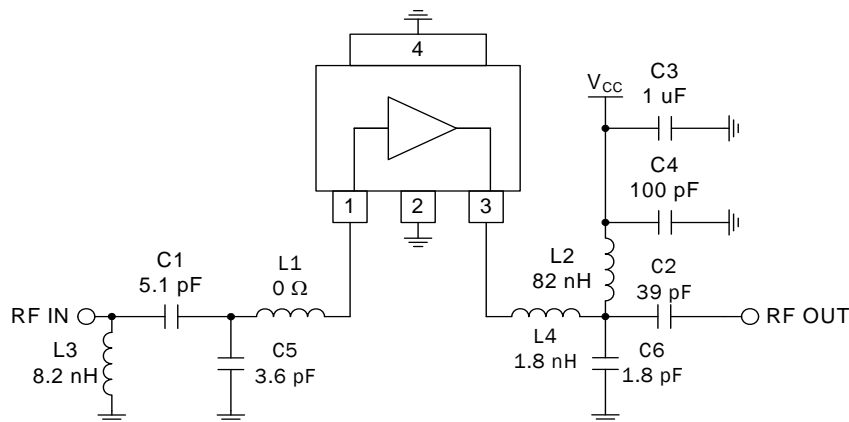

Evaluation Board Schematic for 900MHz

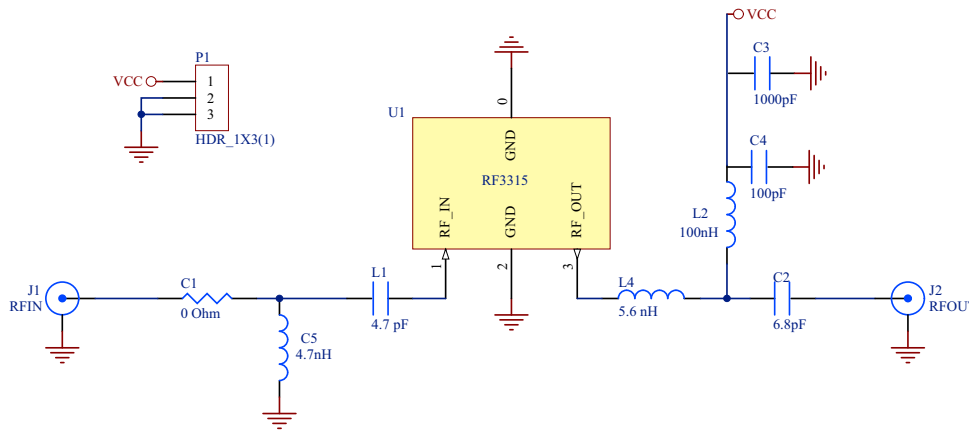

Evaluation Board Bill of Materials (BOM) for 900MHz

Description	Reference Designator	Manufacturer	Manufacturer P/N
3315 Evaluation Board		Dynamic Details (DDI) Toronto	RF3315413(A)
SOT89, High Linearity Amplifier	U1	RFMD	RF3315SB
CAP, 6.8pF, +/-0.1pF, 50V, COG, 0402	C2	Murata Electronics	GRM1555C1H6R8BZ01E
CAP, 1000pF, 10%, 50V, X7R, 0603	C3	Murata Electronics	GRM188R71H102KA01D
CAP, 100pF, 5%, 50V, COG, 0402	C4	TDK Corporation	C1005C0G1H101JT000F
CAP, 4.7pF, +/-0.25pF, 50V, COG, 0402	L1	Murata Electronics	GRM1555C1H4R7CZ01E
RES, 0Ω, 0402	C1	Panasonic Industrial Devices	ERJ-2GE0R00
IND, 4.7nH, 5%, W/W, 0402	C5	Coilcraft	0402CS-4N7XJLW
IND, 100nH, 5%, W/W, 0603	L2	Coilcraft	0603CS-R10XJBC
IND, 5.6nH, 5%, W/W, 0402	L4	Coilcraft	0402CS-5N6XJLW
CONN, SMA, END LNCH, RND, 0.031"	J1-J2	Emerson Network Power	142-0701-881
CONN, HDR, ST, PLRZD, 3-PIN, 0.100"	P1	ITW Pancon	MPSS100-3-C
DNP	C6, L3	N/A	N/A

Evaluation Board Layout for 900MHz Board Size 1.195" x 1.000" Board Thickness 0.033", Board Material FR-4

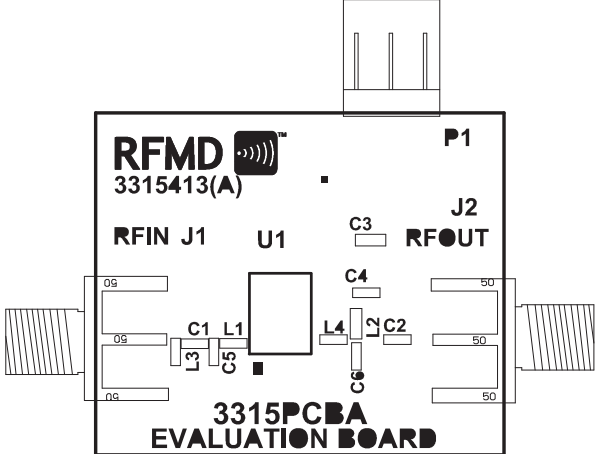

PCB Design Requirements

PCB Surface Finish

The PCB surface finish used for RFMD's qualification process is electroless nickel, immersion gold. Typical thickness is 3µinch to 8µinch gold over 180µinch nickel.

PCB Land Pattern Recommendation

PCB land patterns are based on IPC-SM-782 standards when possible. The pad pattern shown has been developed and tested for optimized assembly at RFMD; however, it may require some modifications to address company specific assembly processes. The PCB land pattern has been developed to accommodate lead and package tolerances.

PCB Metal Land Pattern

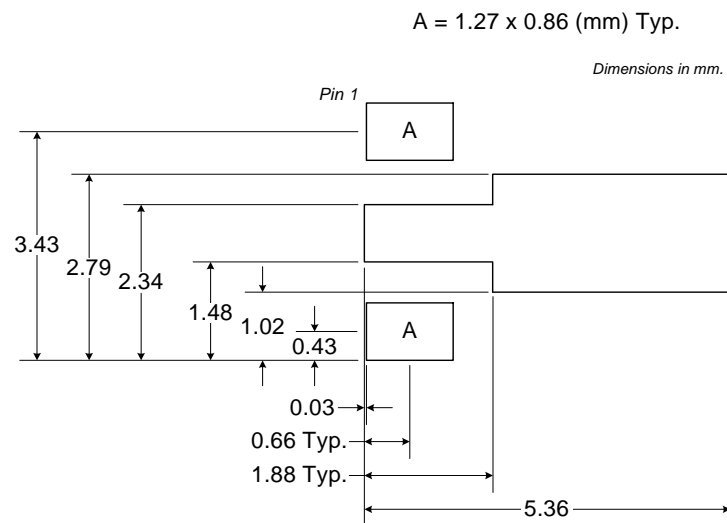

Figure 1. PCB Metal Land Pattern (Top View)

PCB Solder Mask Pattern

Liquid Photo-Imageable (LPI) solder mask is recommended. The solder mask footprint will match what is shown for the PCB metal land pattern with a 2mil to 3mil expansion to accommodate solder mask registration clearance around all pads. The center-grounding pad shall also have a solder mask clearance. Expansion of the pads to create solder mask clearance can be provided in the master data or requested from the PCB fabrication supplier.

$$A = 1.37 \times 0.96 \text{ (mm) Typ.}$$

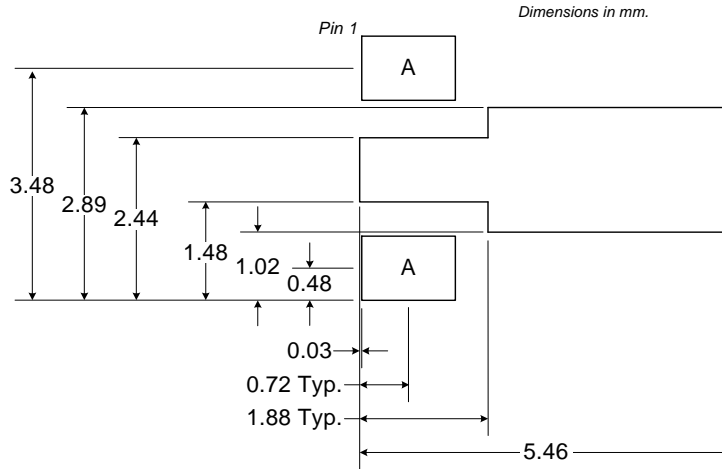
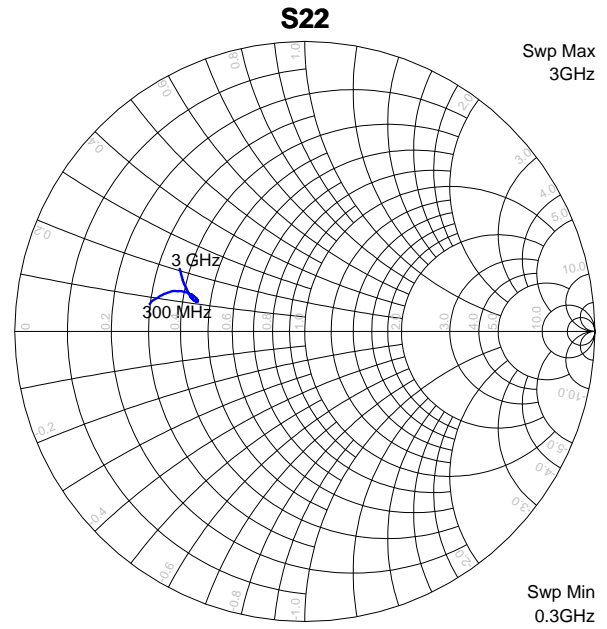
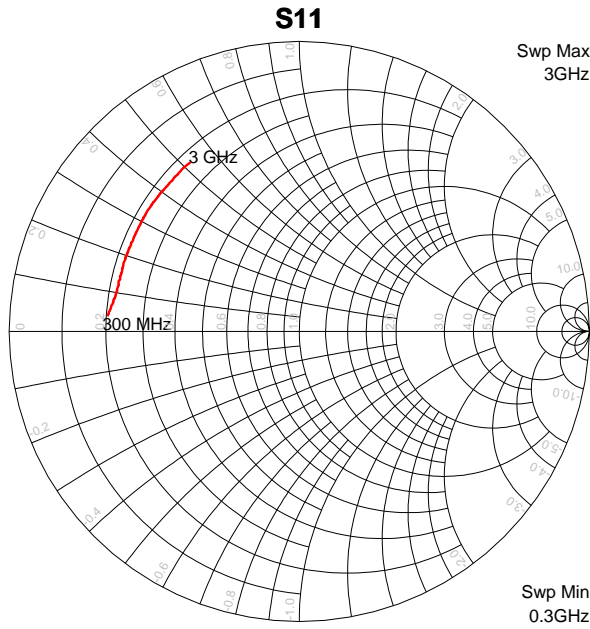

Figure 2. PCB Solder Mask Pattern (Top View)

Thermal Pad and Via Design

Thermal vias are required in the PCB layout to effectively conduct heat away from the package. The via pattern has been designed to address thermal, power dissipation and electrical requirements of the device as well as accommodating routing strategies.

The via pattern used for the RFMD qualification is based on thru-hole vias with 0.203mm to 0.330mm finished hole size on a 0.5mm to 1.2mm grid pattern with 0.025mm plating on via walls. If micro vias are used in a design, it is suggested that the quantity of vias be increased by a 4:1 ratio to achieve similar results.



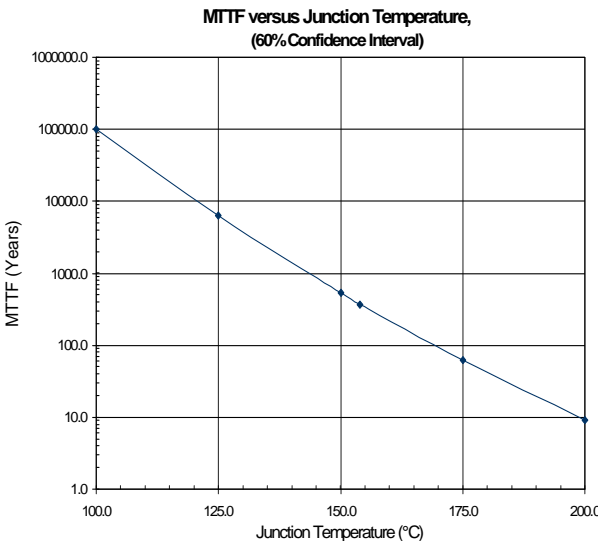
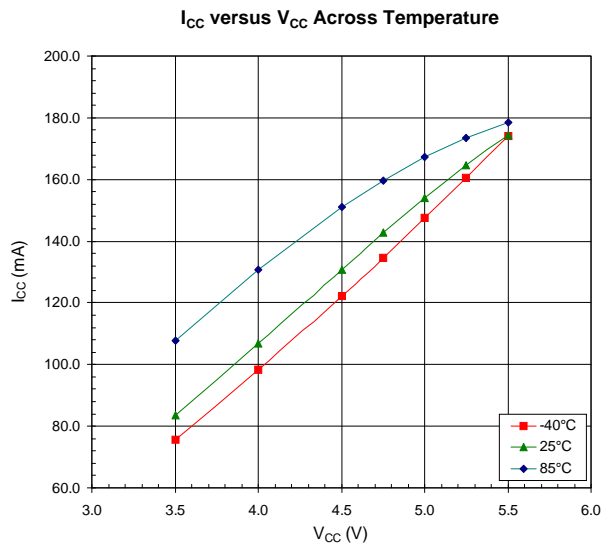
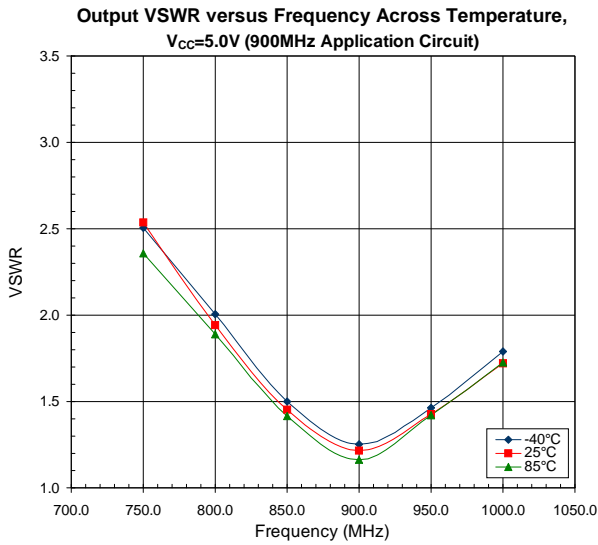
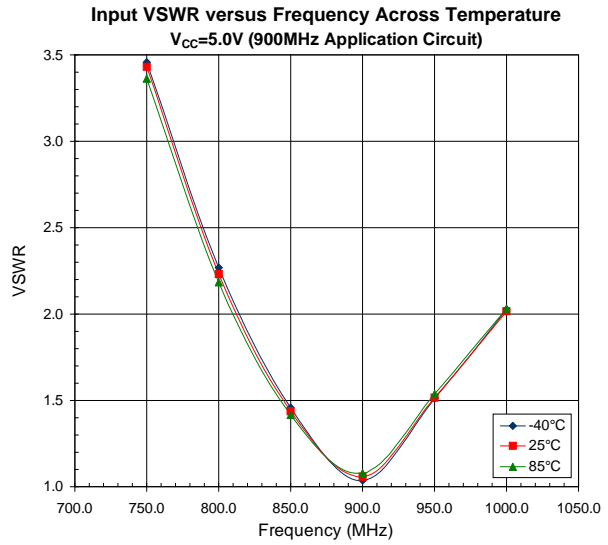
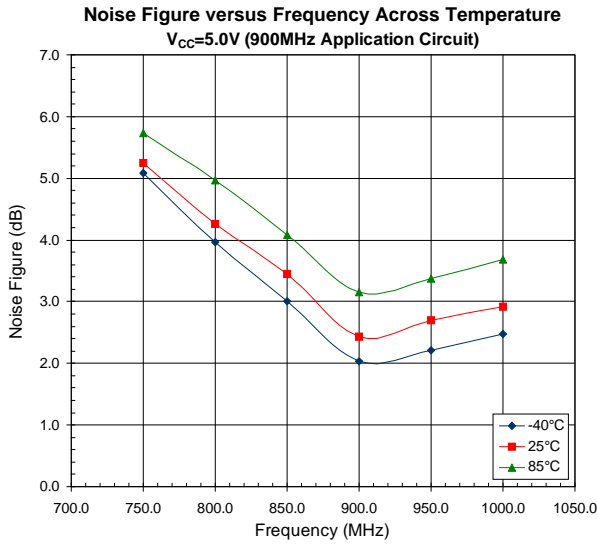

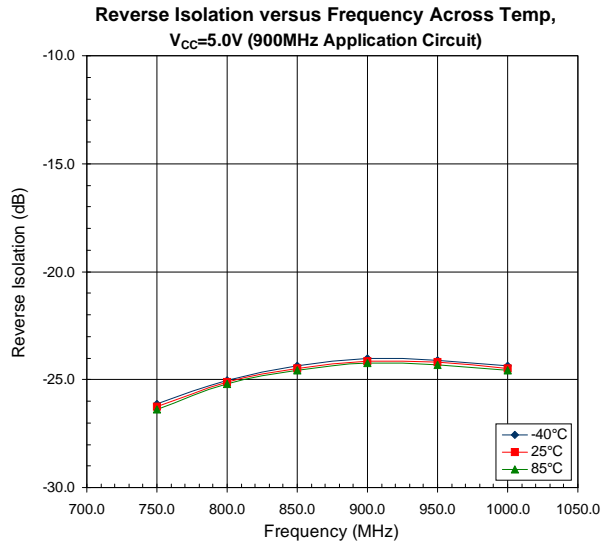
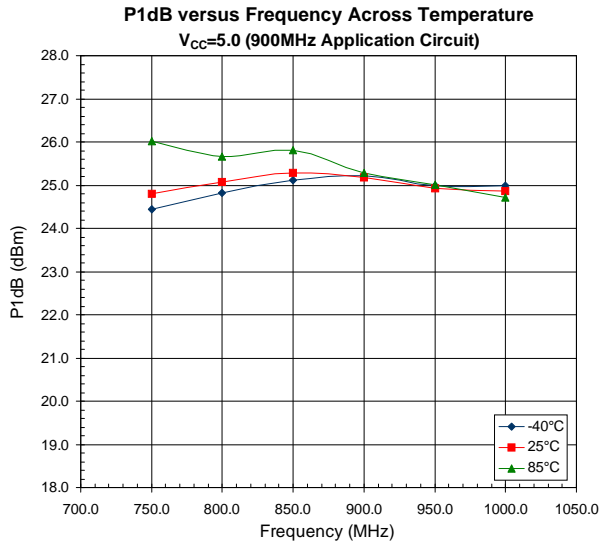
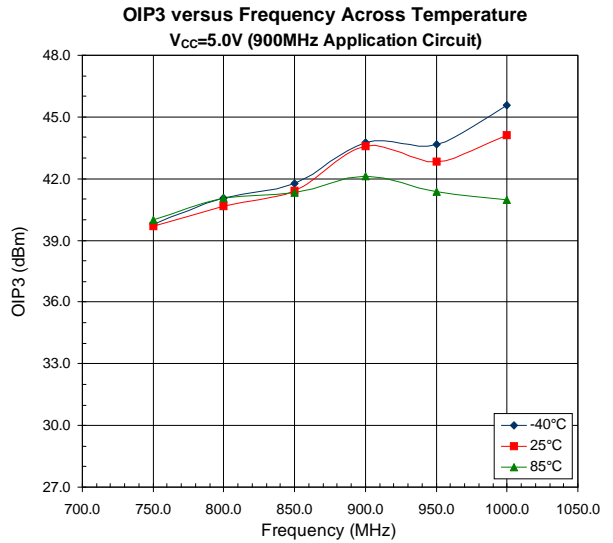
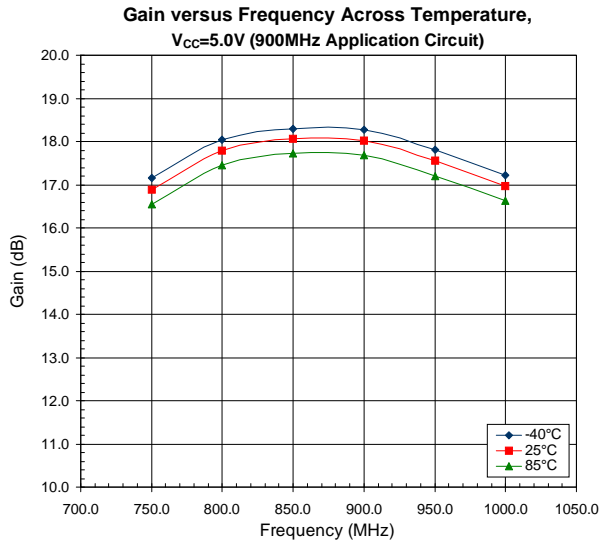
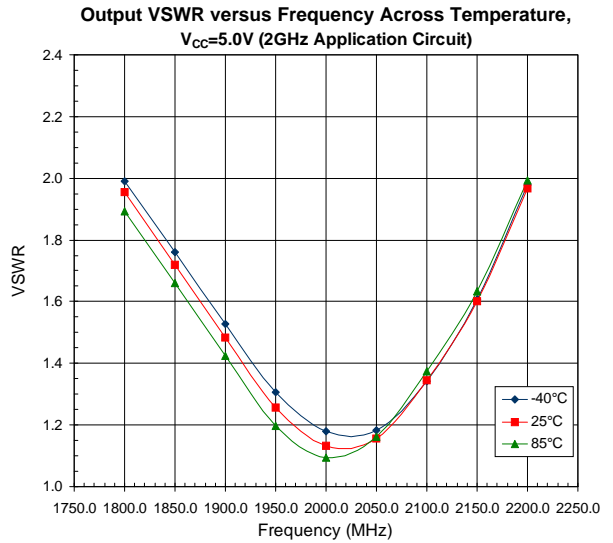
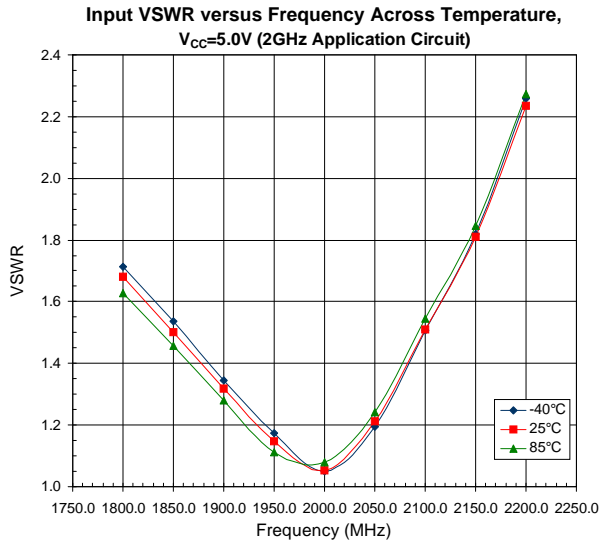

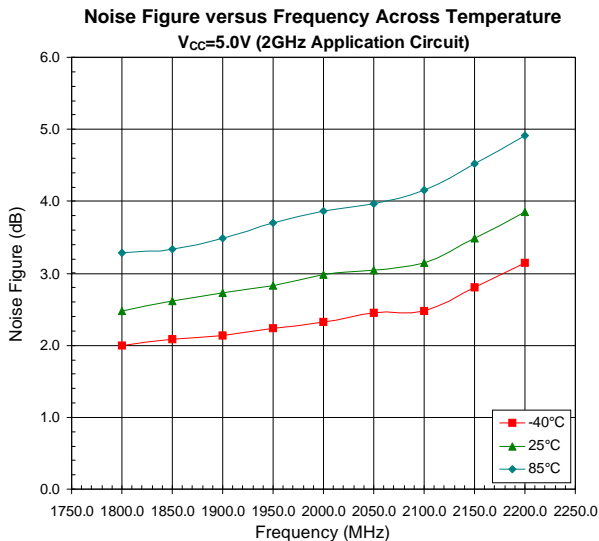
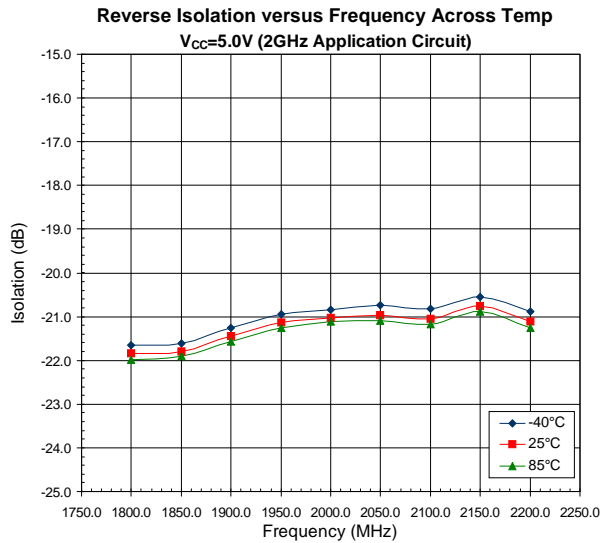
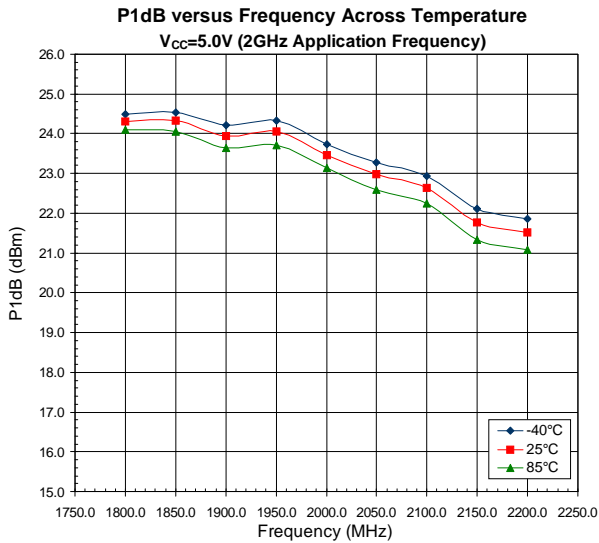
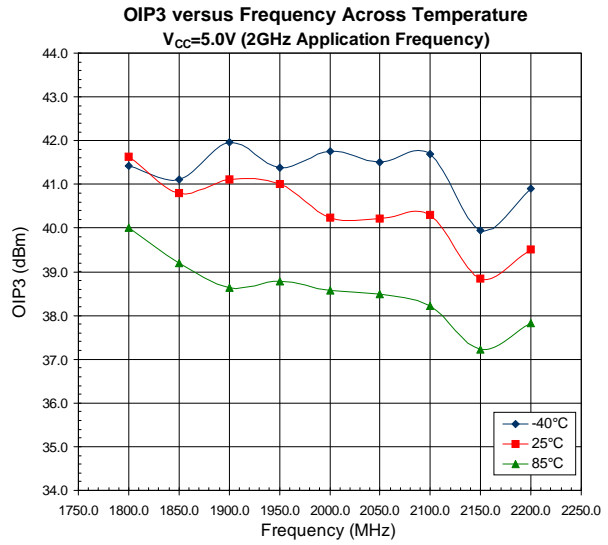
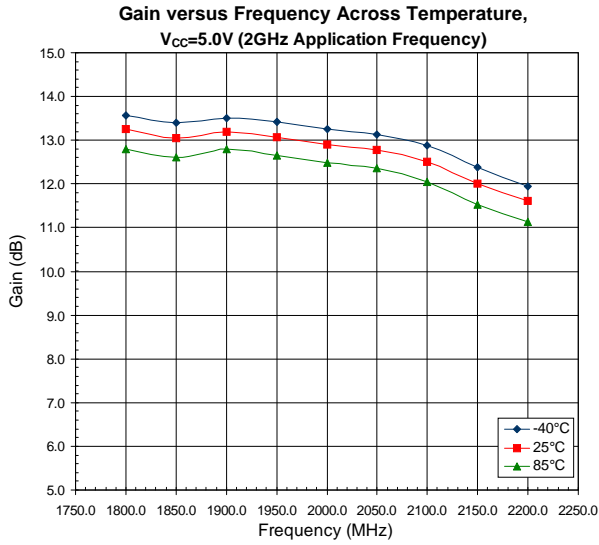

Mouser Electronics

Authorized Distributor

Click to View Pricing, Inventory, Delivery & Lifecycle Information:

Qorvo:

[RF3315TR13](#) [RF3315SR](#)